



PRICE LIST



GENERATOR METER PANELS



ENGINE & COMPRESSOR ACCESSORIES

4430 STEFFANI HOUSTON, TEXAS 77041 (713) 466-8679 FAX (713) 466-8686
TOLL FREE (800) 729-8807 <http://www.daytank.com>

MMP1 MINI METER PANEL



SINGLE PHASE PANEL

For Systems Rated

120 Volts, 1 Phase, 2 Wire
120-240 Volts, 1 Phase, 3 Wire
0-50 Amps, 0-100 Amps, 0-200 Amps

STANDARD EQUIPMENT

- NEMA-1 Heavy Gauge Steel Enclosure
- AC Ammeter, 50, 100, 200 Amp Scale, 3 1/2", 2%
- AC Voltmeter, 0-300 Volt, 3 1/2", 2%
- AC Frequency Meter, Dial Type, 45-65 Hz, 3 1/2", 2%
- Ammeter Switch, 3 Positions, Line 1, Line 2 and Off
- Current Transformers (2), Shipped Loose
- Vibration Isolators (4), Heavy Duty, Shipped Loose
- Fuse Holder with Fuses, 2 Pole
- Terminal Strip



16" W x 4" H x 10" D

Model Number	Description	List Price
SA-02207	120 Volts	\$584.00
SA-01871	120-240 Volts	\$584.00

Options	List Price
50, 100, 150, 200 Amp Ammeter with 50/5, 100/5, 150/5, 200/5 Amp CT's	\$0.00
300 Amp to 600 Amp with CT's	\$17.00
See Page 10 For Mini Meter Panel Options	

THREE PHASE PANEL

For Systems Rated

120/208-139/240 Volts or 277/480 Volts
 3 Phase, 4 Wire
 0-50 Amps , 0-100 Amps, 0-200 Amps



16" W x 4" H x 10" D

STANDARD EQUIPMENT

- NEMA-1 Heavy Gauge Steel Enclosure
- AC Ammeter, 50, 100, or 200 Amp Scale, 3 1/2", 2%
- AC Voltmeter, 0-300 Volts, or 0-600 Volts, 3 1/2", 2%
- AC Frequency Meter, Dial Type, 45-65 Hz, 3 1/2", 2%
- Ammeter Switch, 4 Positions, Line 1, Line 2, Line 3, and Off
- Current Transformers (3), Shipped Loose
- Vibration Isolators (4), Heavy Duty, Shipped Loose
- Fuse Holder with Fuses, 3 Pole
- Terminal Strip

Model Number	Description	List Price
SA-01872	240 Volts	\$652.00
SA-01870	480 Volts	\$726.00

Options	List Price
50, 100, 150, 200 Amp Ammeter with 50/5, 100/5, 150/5, 200/5 Amp CT's	\$0.00
300 Amp to 600 Amp with CT's	\$17.00
See Page 10 For Mini Meter Panel Options	

MMP3 MINI METER PANEL



SINGLE PHASE PANEL

For Systems Rated

120 Volts, 1 Phase, 2 Wire
120-240 Volts, 1 Phase, 3 Wire
0-50 Amps, 0-100 Amps, 0-200 Amps

STANDARD EQUIPMENT

- NEMA-1 Heavy Gauge Steel Enclosure
- AC Ammeter, 50, 100, 200 Amp Scale, 3 1/2", 2%
- AC Voltmeter, 0-300 Volt, 3 1/2", 2%
- AC Frequency Meter, Dial Type, 45-65 Hz, 3 1/2", 2%
- Ammeter Switch, 3 Positions, Line 1, Line 2 and Off
- Current Transformers (2), Shipped Loose
- Vibration Isolators (4), Heavy Duty, Shipped Loose
- Fuse Holder with Fuses, 2 Pole
- Terminal Strip



13 3/8" W x 4" H x 10" D

Model Number	Description	List Price
SA-02208	120 Volts	\$585.00
SA-01873	120-240 Volts	\$585.00

Options	List Price
50, 100, 150, 200 Amp Ammeter with 50/5, 100/5, 150/5, 200/5 Amp CT's	\$0.00
300 Amp to 600 Amp with CT's	\$17.00
See Page 10 For Mini Meter Panel Options	

THREE PHASE PANEL

For Systems Rated

120/208-139/240 Volts or 277/480 Volts
 3 Phase, 4 Wire
 0-50 Amps , 0-100 Amps, 0-200 Amps

STANDARD EQUIPMENT

- NEMA-1 Heavy Gauge Steel Enclosure
- AC Ammeter, 50, 100, or 200 Amp Scale, 3 1/2", 2%
- AC Voltmeter, 0-300 Volts, or 0-600 Volts, 3 1/2", 2%
- AC Frequency Meter, Dial Type, 45-65 Hz, 3 1/2", 2%
- Ammeter Switch, 4 Positions, Line 1, Line 2, Line 3, and Off
- Current Transformers (3), Shipped Loose
- Vibration Isolators (4), Heavy Duty, Shipped Loose
- Fuse Holder with Fuses, 3 Pole
- Terminal Strip



13 3/8" W x 4" H x 10" D

Model Number	Description	List Price
SA-01874	240 Volts	\$652.00
SA-01879	480 Volts	\$726.00

Options	List Price
50, 100, 150, 200 Amp Ammeter with 50/5, 100/5, 150/5, 200/5 Amp CT's	\$0.00
300 Amp to 600 Amp with CT's	\$17.00
See Page 10 For Mini Meter Panel Options	

MMP5 MINI METER PANEL



SINGLE PHASE PANEL

For Systems Rated

120 Volts, 1 Phase, 2 Wire
120-240 Volts, 1 Phase, 3 Wire
0-50 Amps up to 0-600 Amps

STANDARD EQUIPMENT

- NEMA-1 Heavy Gauge Steel Enclosure
- AC Ammeter, 50 to 600 Amp Scale, 3 1/2", 2%
- AC Voltmeter, 0-300 Volt, 3 1/2", 2%
- AC Frequency Meter, Dial Type, 45-65 Hz, 3 1/2", 2%
- Ammeter Switch, 3 Positions, Line 1, Line 2 and Off
- Current Transformers (2), Shipped Loose
- Vibration Isolators (4), Heavy Duty, Shipped Loose
- Fuse Holder with Fuses, 2 Pole
- Terminal Strip



16" W x 7" H x 10" D

Model Number	Description	List Price
SA-02209	120 Volts	\$670.00
SA-01875	120-240 Volts	\$670.00

Options	List Price
50, 100, 150, 200 Amp Ammeter with 50/5, 100/5, 150/5, 200/5 Amp CT's	\$0.00
300 Amp to 600 Amp with CT's	\$17.00
See Page 10 For Mini Meter Panel Options	

THREE PHASE PANEL

For Systems Rated

120/208-139/240 Volts or 277/480 Volts
 3 Phase, 4 Wire
 0-50 Amps up to 0-600 Amps

STANDARD EQUIPMENT

- NEMA-1 Heavy Gauge Steel Enclosure
- AC Ammeter, 50 to 600 Amp Scale, 3 1/2", 2%
- AC Voltmeter, 0-300 Volts, or 0-600 Volts, 3 1/2", 2%
- AC Frequency Meter, Dial Type, 45-65 Hz, 3 1/2", 2%
- Current Transformers (3), Shipped Loose
- Vibration Isolators (4), Heavy Duty, Shipped Loose
- Fuse Holder with Fuses, 3 Pole
- Terminal Strip



16" W x 7" H x 10" D

Model Number	Description	List Price
SA-02038	240 Volts, AM Switch	\$738.00
SA-02040	480 Volts, AM Switch	\$811.00
SA-01876	240 Volts, AM/VM Switch	\$811.00
SA-01877	480 Volts, AM/VM Switch	\$879.00

Options	List Price
50, 100, 150, Amp with 50/5, 100/5, 150/5 Amp CT's	\$0.00
300 Amp to 600 Amp with CT's	\$17.00
See Page 10 For Mini Meter Panel Options	

SMP SMALL METER PANEL

SINGLE AND THREE PHASE PANELS

For Systems Rated

120 Volts, 1 Phase, 2 Wire
 120/240 Volts, 1 Phase, 3 Wire
 120/208-139/240 Volts, 3 Phase, 4 Wire
 277/480 Volts, 3 Phase, 4 Wire
 0-50 Amps up to 0-3000 Amps

STANDARD EQUIPMENT

- NEMA-1 Heavy Gauge Steel Enclosure
- AC Ammeter, 50 to 600 Amp Scale, 3 1/2", 2%
- AC Voltmeter, 0-300 Volts, or 0-600 Volts, 3 1/2", 2%
- AC Frequency Meter, Dial Type, 45-65 Hz, 3 1/2", 2%
- Current Transformers, Shipped Loose
- Vibration Isolators (4), Heavy Duty, Shipped Loose
- Fuse Holder with Fuses, 3 Pole
- Terminal Strip



16" W x 10" H x 8" D

Model Number	Description	List Price
SA-02210	120 Volts, 1 Phase	\$811.00
SA-01861	120/240 Volts , 1 Phase	\$811.00
SA-01878	240 Volts, 3 Phase	\$879.00
SA-01881	480 Volts, 3 Phase	\$953.00

Options	List Price
50, 100, 150, 200 Amp Ammeter with 50/5, 100/5, 150/5, 200/5 Amp CT's	\$0.00
300 Amp to 600 Amp with CT's	\$17.00
See Page 11 For Small Meter Panel Options	

E & C A METER PANELS

STANDARD FACEPLATE (SHOWN WITH OPTIONAL RHEOSTAT)

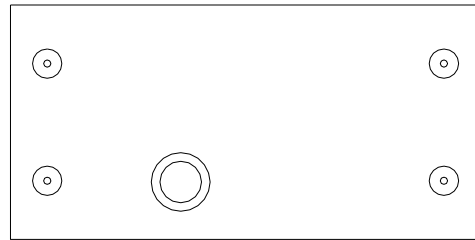
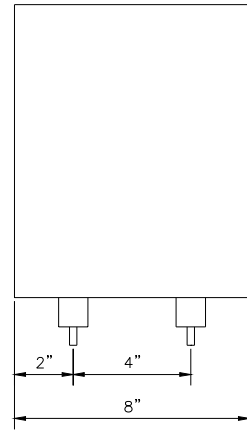
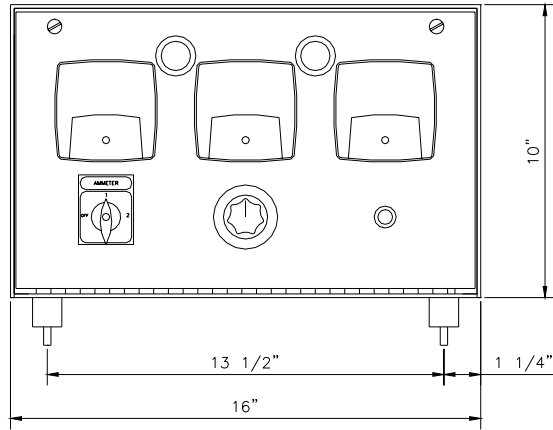

SPECIAL FACEPLATE

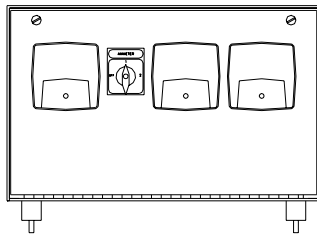

SPECIAL FACEPLATE WITH AUTO START/STOP

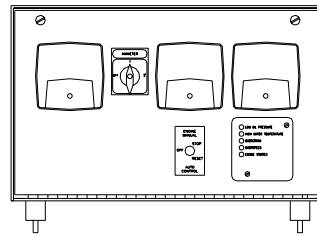

SPECIAL FACEPLATE WITH OPTIONAL GAUGE HOLES

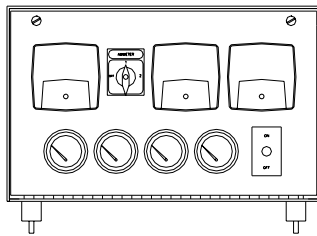

SPECIAL FACEPLATE WITH AUTO START/STOP AND OPTIONAL GAUGE HOLES

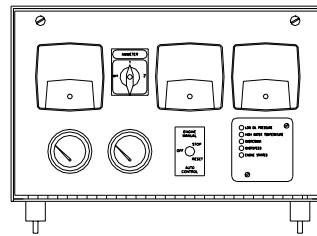

SMALL METER PANEL MODEL SMP AND AVAILABLE FACEPLATES

DRAWING NUMBER 03515	SCALE NONE DATE 12-21-95	APPROVED BY	DRAWN BY TMP REVISION	PROJECT DESCRIPTION	PROJECT NUMBER
-------------------------	--------------------------------	-------------	-----------------------------	---------------------	----------------

MINI METER PANEL OPTIONS

Option Number and Description

PHASE SELECTOR SWITCHES

AM/VM-01834 Combination AM/VM \$85.00
Phase Selector Switch

DIAL TYPE RHEOSTATS

RHE-02219 0-500 Ohm, 35 Watt \$141.00
RHE-02120 0-100 Ohm, 2 Watt \$141.00
RHE-_____ 0-10,000 Ohm, 2 Watt . . . \$141.00
RHE-02121 0-25,000 Ohm, 4 Watt . . . \$141.00
RHE-03018 0-500 Ohm, 3 Watt \$141.00

HOLES, PUNCHED FOR GAUGES, SWITCHES with devices by others

H2 2" or Larger \$57.00
H1 1" or Larger Up To 2" \$28.00

GAUGES

MODELS MMP5 AND MMP6 ONLY

RTM-01351 Running Time Meter \$199.00
2" round, Hrs., non-reset, 24 VDC
DCV DC Voltmeter \$131.00
2" round
OPG-03014 Oil Pressure Gauge \$187.00
12V DC, with sender, 2" round
WTG-03015 Water Temperature Gauge \$125.00
12V DC, with sender, 2" round
Tachometer \$471.00

CURRENT TRANSFORMERS

MODELS MMP1, MMP2, MMP3, MMP4, MMP5, AND MMP6

Standard current transformers Are as follows

0-50 Amp 0-100 Amp
0-150 Amp 0-200 Amp

Adder for 300 Amp to 600 Amp Ammeters with 300/5
to 600/5 current transformers \$17.00

SMALL METER PANEL OPTIONS

Option Number and Description

PHASE SELECTOR SWITCHES

AM/VM-01834 Combination AM/VM \$ 85.00
Phase Selector Switch

DIAL TYPE RHEOSTATS

RHE-02219 0-500 Ohm, 35 Watt \$141.00
RHE-02120 0-100 Ohm, 2 Watt \$141.00
RHE-_____ 0-10,000 Ohm, 2 Watt \$141.00
RHE-02121 0-25,000 Ohm, 4 Watt \$141.00
RHE-03018 0-500 Ohm, 3 Watt \$141.00

START/STOP SYSTEMS

ASS-02420 Automatic Start/Stop . . . \$1,134.00
Engine Controls, 12/24 VDC,
positive or negative fault inputs, with
lights for high water temperature,
low oil pressure, over speed, over
crank, and engine running, with
adjustable cycle crank, with low oil
pressure override timer, with 5 amp
starter and fuel relay output, and
with magnetic input for crank
termination and over speed. High
water temperature, and low oil
pressure contacts by others

MPU-01957 Magnetic Pick Up \$141.00

PR-02022 Power Relay, 24V DC \$85.00
20 amp for starter or for shutdown

PR-02422 Power Relay, 12V DC \$85.00
20 amp for starter or for shutdown

Three Light Shutdown \$556.00
with Permissive Start

Emergency Stop \$189.00
Pushbutton

LAMPS

PIL24-01942 Panel Illumination Lamps . \$162.00
24 VDC, with on-off toggle switch

PIL12-04519 Panel Illumination Lamps . \$162.00
12 VDC, with on-off toggle switch

WEATHER RESISTANT PANELS

WPD-01910 Weather Resistant Door . . \$708.00
Includes seal welded box with back
plate

HOLES, PUNCHED FOR GAUGES, SWITCHES with devices by others

H2 2" or Larger \$57.00

H1 1" or Larger Up To 2" \$28.00

GAUGES

RTM-01351 Running Time Meter \$199.00
2" round, Hrs., non-reset, 24 VDC

DCV DC Voltmeter \$131.00
2" round

OPG-03014 Oil Pressure Gauge \$187.00
12V DC, with sender, 2" round

WTG-03015 Water Temperature Gauge \$125.00
12V DC with sender, 2" round

Tachometer \$471.00

CURRENT TRANSFORMERS

MODEL SMP

Standard current transformers and meters are as
follows:

0-50 Amp	0-200 Amp	0-500 Amp
0-100 Amp	0-300 Amp	0-600 Amp
0-150 Amp	0-400 Amp	

For larger current transformers and meters add the
following:

0-800	\$28.00
0-1000	\$37.00
0-1200	\$178.00
0-1500	\$213.00
0-2000	\$234.00





E & C A enjoys worldwide recognition and leadership with our line of automatic day tanks as well as our economy automatic day tanks, and fuel tanks. An outgrowth of our position of leadership in the automatic day tank business is a broad line of secondary containment (double wall) day tanks, slim day tanks and generator base tanks. With the experience we gained in creating the day tank controls, we developed a line of meter panels as an added convenience for our customers.

*E & C A was founded by Thomas E. Pafford, a registered professional engineer in the state of Texas. Soon after graduating from the University of Oklahoma in 1954 he went to work as a design engineer and sales representative for a major supplier of instrumentation and process controls. His work in the design and sales of instrumentation and process controls brought him to Houston where he became a sales representative for a major line of generators and several lines of tanks. The frustration of trying to assure quality in the day tank equipment he sold forced him to "build it himself" and become a manufacturer. With his expertise and background he was asked by several organizations to develop many of the standards and codes that are currently used by other day tank manufacturers. The excellent growth rate of **Engine & Compressor Accessories** reflects his dedication and concern for quality.*

In the last decade E & C A has grown to become one of the world's leading manufacturers of automatic day tank and generator base tank systems. We supply tanks to many of the world's largest gen set manufacturers and assemblers. We pride ourselves in giving the customer the highest quality product for their money while still being competitively priced.

*Engine & Compressor Accessories' standard of excellence assures our customers of dependable and reliable products. Our tanks are **strenuously** tested to meet or exceed the latest standards and do not leave the factory unless they have passed **two** separate examinations. In looking toward the future, E & C A continues to strive for excellence assuring our customers quality equipment and dependable service.*

SEE OUR OTHER BROCHURES ON:

DAY TANKS

UL LISTED:

- AUTOMATIC DAY TANKS
- ECONOMY AUTOMATIC DAY TANKS
- FUEL TANKS
- SECONDARY CONTAINMENT (DOUBLE WALL) DAY TANKS
- SECONDARY CONTAINMENT (DOUBLE WALL) FUEL TANKS
- SLIM TANKS
- PUMPING UNITS

GENERATOR BASE TANKS

UL LISTED

- GENERATOR BASE TANKS
- OPEN TOP DIKED GENERATOR BASE TANKS
- CLOSED TOP GENERATOR BASE TANKS
- SECONDARY CONTAINMENT GENERATOR BASE TANKS

GENERATOR ENCLOSURES

WEATHER RESISTANT ENCLOSURES

ALL PRICES HEREIN ARE LIST PRICES AND
ARE SUBJECT TO CHANGE WITHOUT NOTICE.
F.O.B. HOUSTON, TEXAS, U.S.A.
ENGINE & COMPRESSOR ACCESSORIES
4430 STEFFANI, HOUSTON, TEXAS 77041
(713) 466-8679 (800) 729-8807 FAX (713) 466-8686
<http://www.daytank.com>